

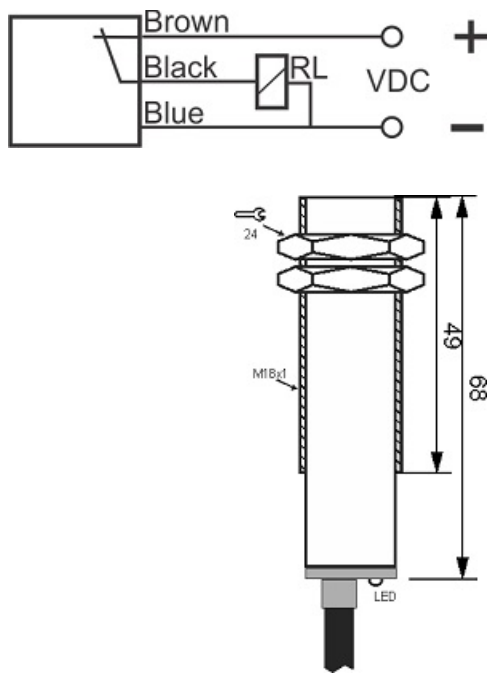

IPS-305-CP-18

Category: 3wire DC pre cabled PNP inductive sensor



IPS-305-CP-18	Product Code
M18X1Ni PLATED Brass	housing
3	number of wires
5 mm	switching distance
-20~+60 °C	temperature range
IP67	influence protection
CABLE3X0.25-1.5m	output
PNP TRANSISTOR	output stage
NC	output function
10-30VDC	voltage range
250 mA	max output current
700 Hz	max output frequency
✓	indicator led
2 V	max drop voltage
15 mA	max noload or leakage current
3 bar	pressure rate
flush(shielded)	mounting
yes	revers voltage protection
yes	short circuit protection
yes	pick voltage protection

Address: No.36 , Karimkhan Ave , Darvazeh Tehran ,Tabriz-Iran

Postal Code : 5157913399 | Post Inbox : 5341-51575 | Phone : 33330490-041 | Fax : 33318200-041

Website : www.tabrizpeguh.com | Email : info@tabrizpeguh.com