

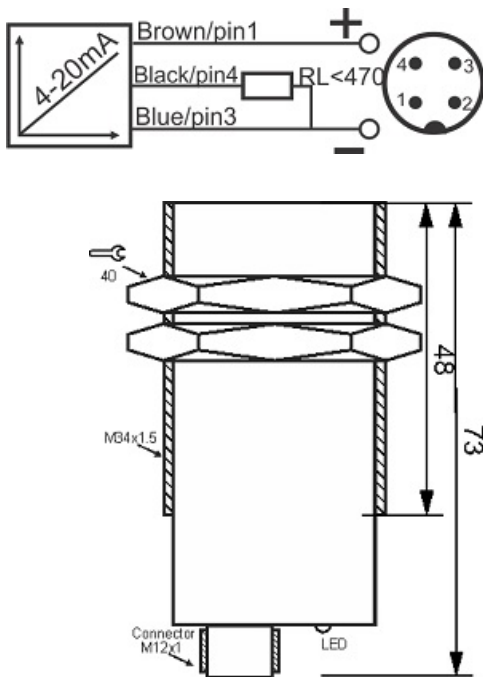

IPS-315-AI-34-P-S4

Category: continuous 4pin connector Inductive Sensor



IPS-315-AI-34-P-S4	Product Code
M34X1.5Ni PLATED Brass	housing
3	number of wires
4-20mA	output type
15 mm	switching distance
-20~+60 °C	temperature range
IP66	influence protection
4Pin SOCKET	output
TRANSISTOR	output stage
15-30 VDC	voltage range
flush(shielded)	mounting

Address: No.36 , Karimkhan Ave , Darvazeh Tehran ,Tabriz-Iran

Postal Code : 5157913399 | Post Inbox : 5341-51575 | Phone : 33330490-041 | Fax : 33318200-041

Website : www.tabrizpeguh.com | Email : info@tabrizpeguh.com