

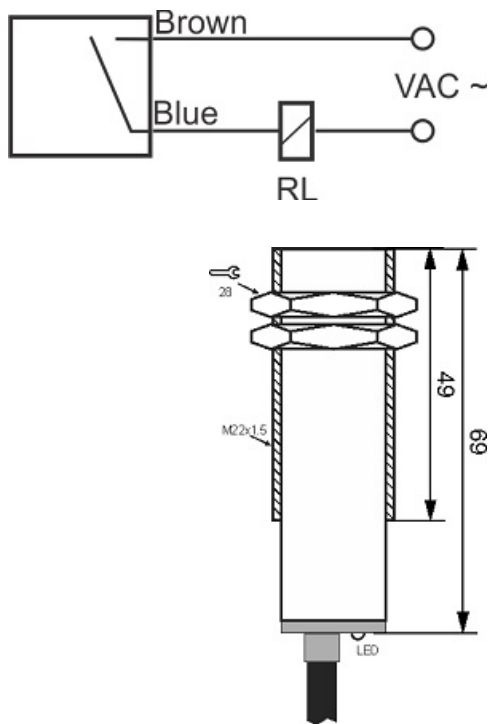

# IPS-208-OA-22-HT

Category: high temperature pre cabled inductive sensor



IPS-208-OA-22-HT	Product Code
M22X1.5Ni PLATED Brass	housing
2	number of wires
8 mm	switching distance
-20~+120 °C	temperature range
IP67	influence protection
CABLE2X0.35-1.5m	output
THYRISTOR	output stage
NO	output function
90-250VAC	voltage range
250 mA	max output current
✓	indicator led
10 V	max drop voltage
flush(shielded)	mounting

Address: No.36 , Karimkhan Ave , Darvazeh Tehran ,Tabriz-Iran

Postal Code : 5157913399 | Post Inbox : 5341-51575 | Phone : 33330490-041 | Fax : 33318200-041

Website : [www.tabrizpeguh.com](http://www.tabrizpeguh.com) | Email : [info@tabrizpeguh.com](mailto:info@tabrizpeguh.com)