

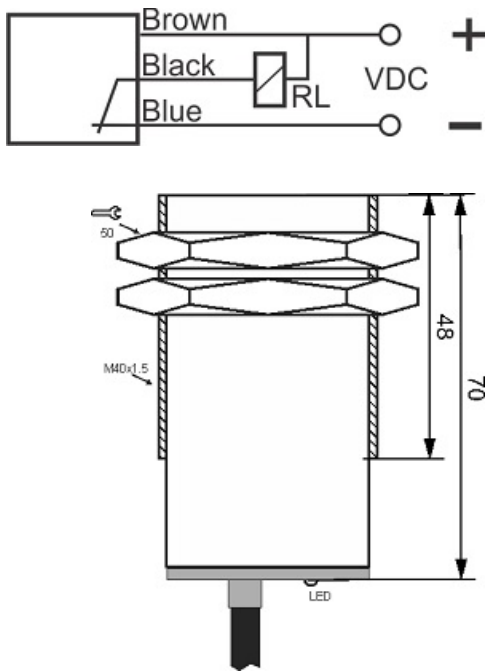

IPS-320-CN-40-HT

Category: high temperature pre cabled inductive sensor



IPS-320-CN-40-HT	Product Code
M40X1.5Ni PLATED Brass	housing
3	number of wires
20 mm	switching distance
-20~+120 °C	temperature range
IP67	influence protection
CABLE3X0.35-1.5m	output
NPN TRANSISTOR	output stage
NC	output function
10-30VDC	voltage range
250 mA	max output current
✓	indicator led
2 V	max drop voltage
flush(shielded)	mounting

Address: No.36 , Karimkhan Ave , Darvazeh Tehran ,Tabriz-Iran

Postal Code : 5157913399 | Post Inbox : 5341-51575 | Phone : 33330490-041 | Fax : 33318200-041

Website : www.tabrizpeguh.com | Email : info@tabrizpeguh.com