

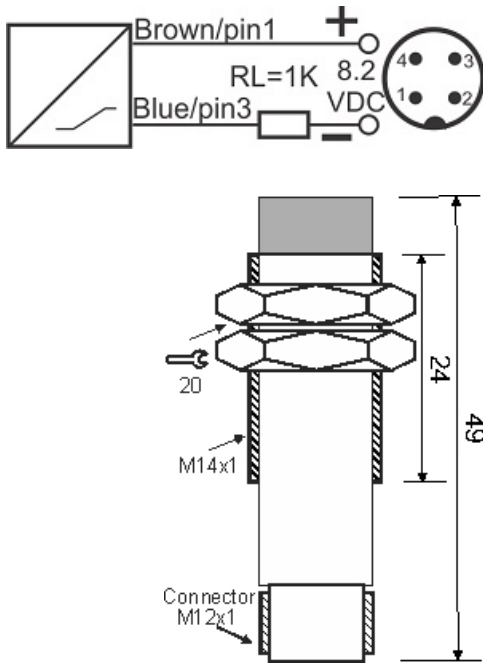

IPS-205-NM-14-S4

Category: 4pin connector namur sensors



IPS-205-NM-14-S4	Product Code
M14X1Ni PLATED Brass	housing
2	number of wires
5 mm	switching distance
-20~+60 °C	temperature range
IP67	influence protection
4Pin SOCKET	output
NAMUR	output function
8.2VDC	voltage range
1000 Hz	max output ferequence
0	indicator led
non flush (unshielded)	mounting

Address: No.36 , Karimkhan Ave , Darvazeh Tehran ,Tabriz-Iran

Postal Code : 5157913399 | Post Inbox : 5341-51575 | Phone : 33330490-041 | Fax : 33318200-041

Website : www.tabrizpeguh.com | Email : info@tabrizpeguh.com