

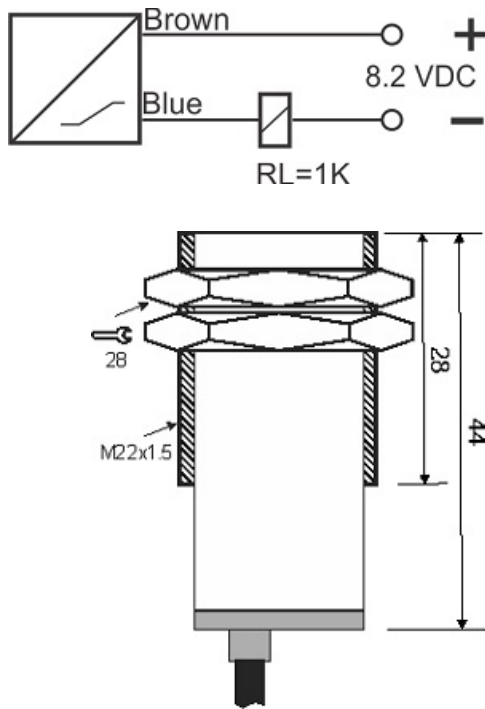

IPS-208-Nm-22-HT

Category: high temperature pre cabled inductive sensor



IPS-208-Nm-22-HT	Product Code
M22X1.5Ni PLATED Brass	housing
2	number of wires
8 mm	switching distance
-20~+120 °C	temperature range
500 Hz	max operating frequency
IP67	influence protection
SILICON CABLE2X0.25-1.5m	output
NAMUR	output function
8.2VDC	voltage range
0	indicator led
flush(shielded)	mounting

Address: No.36 , Karimkhan Ave , Darvazeh Tehran ,Tabriz-Iran

Postal Code : 5157913399 | Post Inbox : 5341-51575 | Phone : 33330490-041 | Fax : 33318200-041

Website : www.tabrizpeguh.com | Email : info@tabrizpeguh.com