

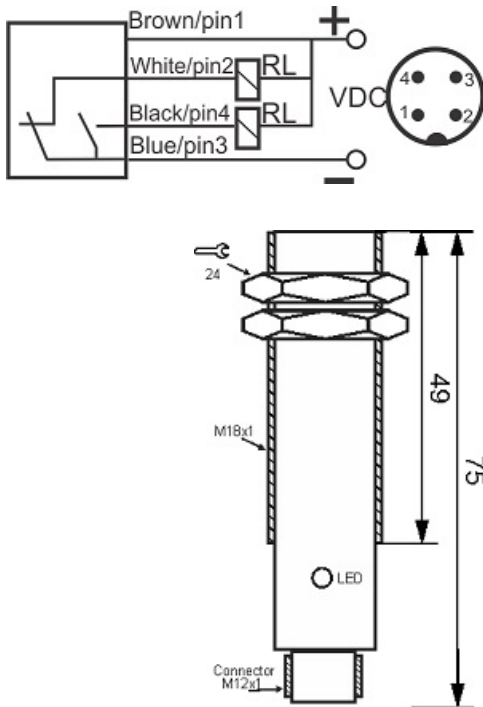

# OPS-4300-N-18-TB-RC-S4

Category: 4pin connector through-beam optoelectronic sensors-receiver



OPS-4300-N-18-TB-RC-S4	Product Code
M18X1 Ni PLATED Brass	housing
4	number of wires
NPN TRANSISTOR	output stage
NO+NC	output function
300 cm	switching distance
10-30VDC	voltage range
250 mA	max output current
-20~+60 °C	temperature range
100 Hz	max output ferequence
✓	indicator led
2 V	max drop voltage
25 mA	max curtrent consumption
IP 66	influence protection
✓	revers voltage protection
0	short circuit protection
4Pin SOCKET	output

Address: No.36 , Karimkhan Ave , Darvazeh Tehran ,Tabriz-Iran

Postal Code : 5157913399 | Post Inbox : 5341-51575 | Phone : 33330490-041 | Fax : 33318200-041

Website : [www.tabrizpeguh.com](http://www.tabrizpeguh.com) | Email : [info@tabrizpeguh.com](mailto:info@tabrizpeguh.com)