

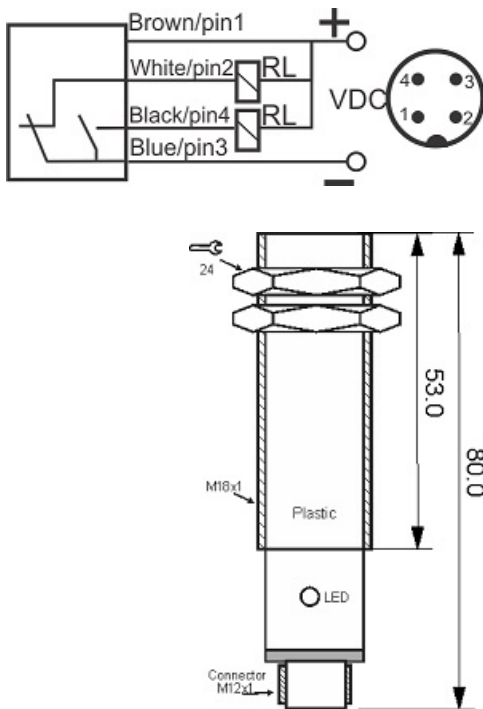

OPS-4300-N-P18-TB-RC

Category: 4pin connector through-beam optoelectronic sensors-receiver



| | |
|----------------------|---------------------------|
| OPS-4300-N-P18-TB-RC | Product Code |
| M18X1 PBT | housing |
| 4 | number of wires |
| NPN TRANSISTOR | output stage |
| NO+NC | output function |
| 300 cm | switching distance |
| 10-30VDC | voltage range |
| 250 mA | max output current |
| -20~+60 °C | temperature range |
| 100 Hz | max output ferequence |
| ✓ | indicator led |
| 2 V | max drop voltage |
| 25 mA | max curtrent consumption |
| IP 66 | influence protection |
| ✓ | revers voltage protection |
| 0 | short circuit protection |
| 4Pin SOCKET | output |

Address: No.36 , Karimkhan Ave , Darvazeh Tehran ,Tabriz-Iran

Postal Code : 5157913399 | Post Inbox : 5341-51575 | Phone : 33330490-041 | Fax : 33318200-041

Website : www.tabrizpeguh.com | Email : info@tabrizpeguh.com