

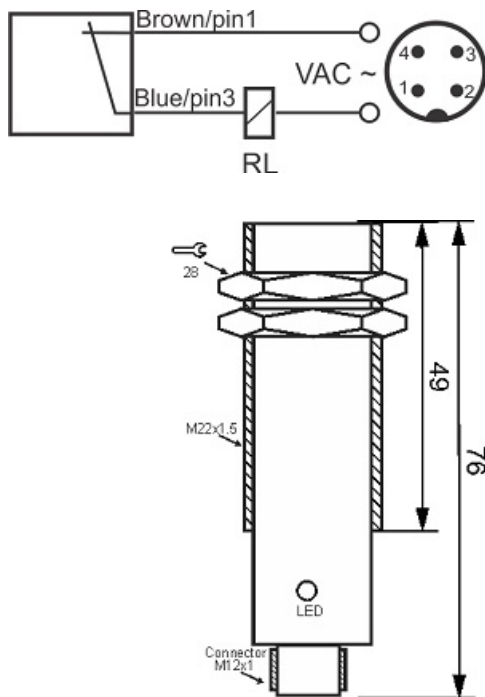

IPS-208-CA-22-V-S4

Category: 2wire AC 4pin connector inductive sensor



| | |
|------------------------|-------------------------------|
| IPS-208-CA-22-V-S4 | Product Code |
| M22X1.5Ni PLATED Brass | housing |
| 2 | number of wires |
| 8 mm | switching distance |
| -20~+60 °C | temperature range |
| IP 66 | influence protection |
| 4Pin SOCKET | output |
| THYRISTOR | output stage |
| NC | output function |
| 20-250VAC | voltage range |
| 250 mA | max output current |
| 20 Hz | max output frequency |
| ✓ | indicator led |
| 10 V | max drop voltage |
| 3 mA | max noload or leakage current |
| 3 bar | pressure rate |
| flush(shielded) | mounting |
| 0 | revers voltage protection |
| 0 | short circuit protection |
| yes | pick voltage protection |

Address: No.36 , Karimkhan Ave , Darvazeh Tehran ,Tabriz-Iran

Postal Code : 5157913399 | Post Inbox : 5341-51575 | Phone : 33330490-041 | Fax : 33318200-041

Website : www.tabrizpeguh.com | Email : info@tabrizpeguh.com