

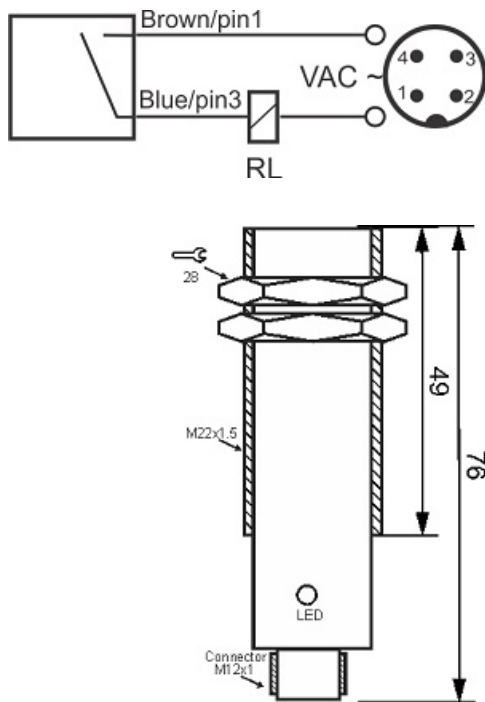

IPS-208-OA-22-S4

Category: 2wire AC 4pin connector inductive sensor



IPS-208-OA-22-S4	Product Code
M22X1.5Ni PLATED Brass	housing
2	number of wires
8 mm	switching distance
-20~+60 °C	temperature range
IP 66	influence protection
4Pin SOCKET	output
THYRISTOR	output stage
NO	output function
90-250VAC	voltage range
250 mA	max output current
20 Hz	max output frequency
✓	indicator led
10 V	max drop voltage
3 mA	max noload or leakage current
3 bar	pressure rate
flush(shielded)	mounting
0	revers voltage protection
0	short circuit protection
yes	pick voltage protection

Address: No.36 , Karimkhan Ave , Darvazeh Tehran ,Tabriz-Iran

Postal Code : 5157913399 | Post Inbox : 5341-51575 | Phone : 33330490-041 | Fax : 33318200-041

Website : www.tabrizpeguh.com | Email : info@tabrizpeguh.com