

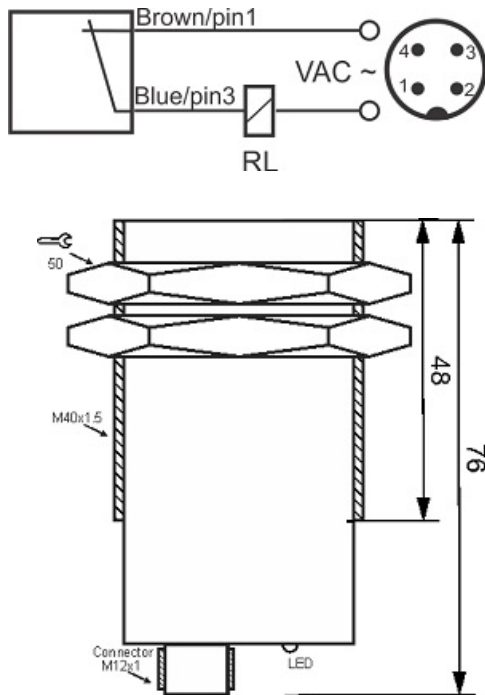

# IPS-220-CA-40-V-S4

Category: 2wire AC 4pin connector inductive sensor



IPS-220-CA-40-V-S4	Product Code
M40X1.5Ni PLATED Brass	housing
2	number of wires
20 mm	switching distance
-20~+60 °C	temperature range
IP 66	influence protection
4Pin SOCKET	output
THYRISTOR	output stage
NC	output function
20-250VAC	voltage range
250 mA	max output current
20 Hz	max output frequency
✓	indicator led
10 V	max drop voltage
3 mA	max noload or leakage current
3 bar	pressure rate
flush(shielded)	mounting
0	revers voltage protection
0	short circuit protection
yes	pick voltage protection

Address: No.36 , Karimkhan Ave , Darvazeh Tehran ,Tabriz-Iran

Postal Code : 5157913399 | Post Inbox : 5341-51575 | Phone : 33330490-041 | Fax : 33318200-041

Website : [www.tabrizpeguh.com](http://www.tabrizpeguh.com) | Email : [info@tabrizpeguh.com](mailto:info@tabrizpeguh.com)