

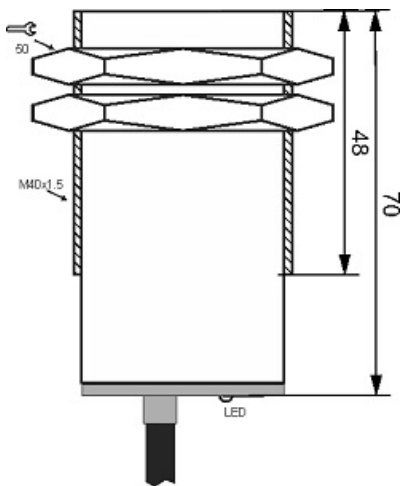

IPS-220-OD-40

Category: 2wire DC pre cabled inductive sensor

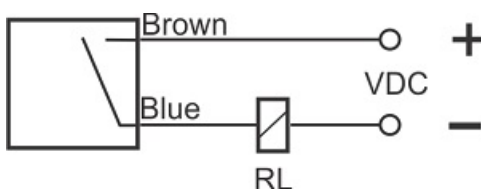
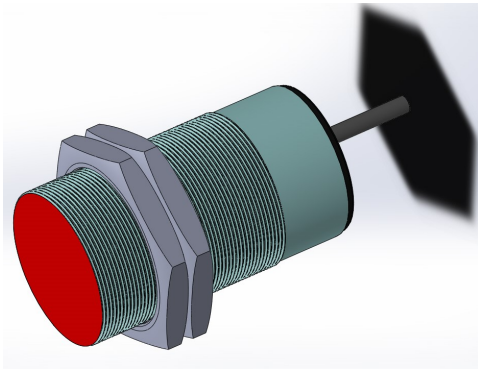

| | |
|------------------------|-------------------------------|
| IPS-220-OD-40 | Product Code |
| M40X1.5Ni PLATED Brass | housing |
| 2 | number of wires |
| 20 mm | switching distance |
| -20~+60 °C | temperature range |
| IP67 | influence protection |
| CABLE2X0.5-1.5m | output |
| TRANSISTOR | output stage |
| NO | output function |
| 10-30VDC | voltage range |
| 120 mA | max output current |
| 300 Hz | max output frequency |
| ✓ | indicator led |
| 5 V | max drop voltage |
| 2 mA | max noload or leakage current |
| 3 bar | pressure rate |
| flush(shielded) | mounting |
| yes | revers voltage protection |
| 0 | short circuit protection |
| yes | pick voltage protection |

Address: No.36 , Karimkhan Ave , Darvazeh Tehran ,Tabriz-Iran

Postal Code : 5157913399 | Post Inbox : 5341-51575 | Phone : 33330490-041 | Fax : 33318200-041

Website : www.tabrizpeguh.com | Email : info@tabrizpeguh.com