

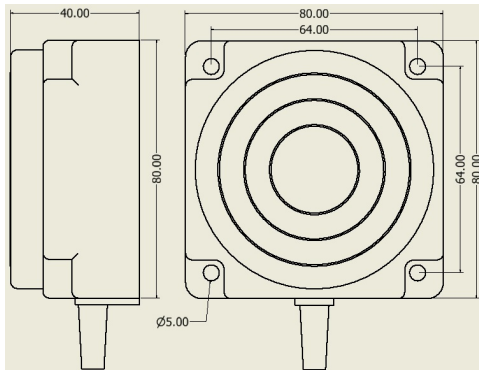

# IPS-235-OD-R80

Category: 2wire DC pre cabled inductive sensor

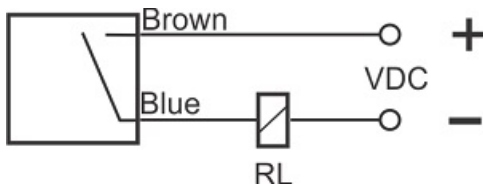

IPS-235-OD-R80	Product Code
REC. 80X80X40 PA or PP	housing
2	number of wires
35 mm	switching distance
-20~+60 °C	temperature range
IP67	influence protection
CABLE2X0.5-1.5m	output
TRANSISTOR	output stage
NO	output function
10-30VDC	voltage range
120 mA	max output current
100 Hz	max output frequency
✓	indicator led
5 V	max drop voltage
2 mA	max noload or leakage current
3 bar	pressure rate
non flush (unshielded)	mounting
yes	revers voltage protection
0	short circuit protection
yes	pick voltage protection

Address: No.36 , Karimkhan Ave , Darvazeh Tehran ,Tabriz-Iran

Postal Code : 5157913399 | Post Inbox : 5341-51575 | Phone : 33330490-041 | Fax : 33318200-041

Website : [www.tabrizpeguh.com](http://www.tabrizpeguh.com) | Email : [info@tabrizpeguh.com](mailto:info@tabrizpeguh.com)