

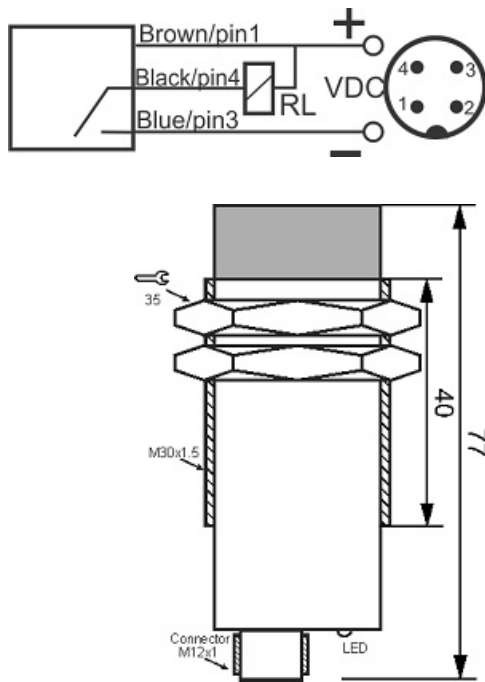

# IPS-315-ON-30-S4

Category: 3wire DC 4pin connector NPN inductive sensor



|                        |                               |
|------------------------|-------------------------------|
| IPS-315-ON-30-S4       | Product Code                  |
| M30X1.5Ni PLATED Brass | housing                       |
| 3                      | number of wires               |
| 15 mm                  | switching distance            |
| -20~+60 °C             | temperature range             |
| IP66                   | influence protection          |
| 4Pin SOCKET            | output                        |
| NPN TRANSISTOR         | output stage                  |
| NO                     | output function               |
| 10-30VDC               | voltage range                 |
| 250                    | max output current            |
| 300 Hz                 | max output frequency          |
| ✓                      | indicator led                 |
| 2 V                    | max drop voltage              |
| 15 mA                  | max noload or leakage current |
| 3 bar                  | pressure rate                 |
| non flush (unshielded) | mounting                      |
| yes                    | revers voltage protection     |
| yes                    | short circuit protection      |
| yes                    | pick voltage protection       |

Address: No.36 , Karimkhan Ave , Darvazeh Tehran ,Tabriz-Iran

Postal Code : 5157913399 | Post Inbox : 5341-51575 | Phone : 33330490-041 | Fax : 33318200-041

Website : [www.tabrizpeguh.com](http://www.tabrizpeguh.com) | Email : [info@tabrizpeguh.com](mailto:info@tabrizpeguh.com)