

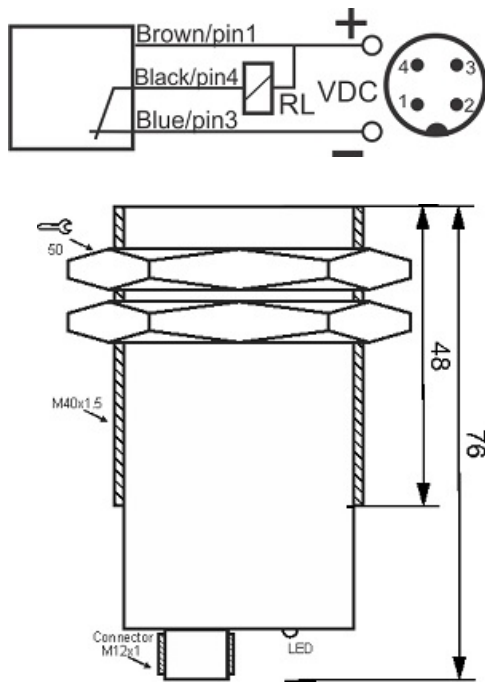

IPS-320-CN-40-V-S4

Category: 3wire DC 4pin connector NPN inductive sensor



IPS-320-CN-40-V-S4	Product Code
M40X1.5Ni PLATED Brass	housing
3	number of wires
20 mm	switching distance
-20~+60 °C	temperature range
IP66	influence protection
4Pin SOCKET	output
NPN TRANSISTOR	output stage
NC	output function
10-60VDC	voltage range
250	max output current
300 Hz	max output frequency
✓	indicator led
2 V	max drop voltage
15 mA	max noload or leakage current
3 bar	pressure rate
flush(shielded)	mounting
yes	revers voltage protection
yes	short circuit protection
yes	pick voltage protection

Address: No.36 , Karimkhan Ave , Darvazeh Tehran ,Tabriz-Iran

Postal Code : 5157913399 | Post Inbox : 5341-51575 | Phone : 33330490-041 | Fax : 33318200-041

Website : www.tabrizpeguh.com | Email : info@tabrizpeguh.com