

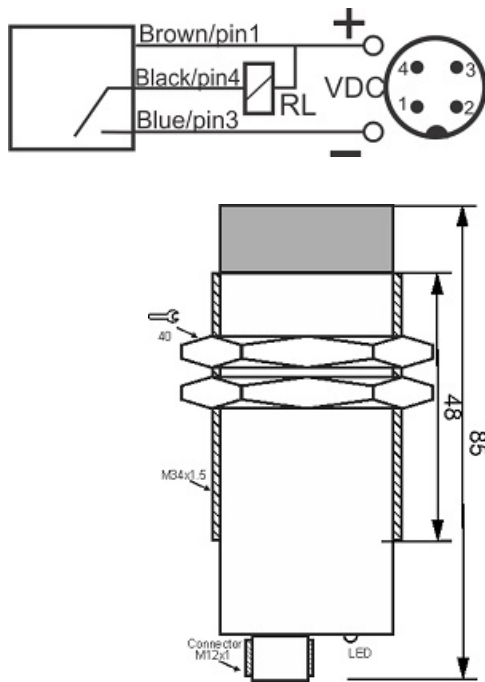

# IPS-320-ON-34-S4

Category: 3wire DC 4pin connector NPN inductive sensor



IPS-320-ON-34-S4	Product Code
M34X1.5Ni PLATED Brass	housing
3	number of wires
20 mm	switching distance
-20~+60 °C	temperature range
IP66	influence protection
4Pin SOCKET	output
NPN TRANSISTOR	output stage
NO	output function
10-30VDC	voltage range
250	max output current
300 Hz	max output frequency
✓	indicator led
2 V	max drop voltage
15 mA	max noload or leakage current
3 bar	pressure rate
non flush (unshielded)	mounting
yes	revers voltage protection
yes	short circuit protection
yes	pick voltage protection

Address: No.36 , Karimkhan Ave , Darvazeh Tehran ,Tabriz-Iran

Postal Code : 5157913399 | Post Inbox : 5341-51575 | Phone : 33330490-041 | Fax : 33318200-041

Website : [www.tabrizpeguh.com](http://www.tabrizpeguh.com) | Email : [info@tabrizpeguh.com](mailto:info@tabrizpeguh.com)